

Vista by CRS Pianca



IT Si abbina alle cabine armadio Pianca con i toni della discrezione e della sobrietà, al fine di creare una divisione osmotica tra gli spazi. Pulizia formale, leggerezza, modularità al centimetro rendono Vista un sistema di chiusura minimale ed estremamente versatile. Caratteristica principale è la totale assenza di telai, in entrambe le versioni di anta, in legno e in vetro. Monorotaia o birotaia, la struttura dei binari in alluminio può essere fissata a parete, a soffitto o ad incasso, per un incredibile effetto a scomparsa

EN The perfect item to complement Pianca walk-in closets; available in multiple finishes these doors create an osmotic division between spaces. Formal cleanliness, lightness, modularity down to the centimeter make Vista a minimal and extremely versatile door system. The main feature is the total absence of frames, in both versions of these doors, in wood and in glass. Single or double track, the structure of the aluminum rails can be fixed to the wall, ceiling or recessed, for an incredible concealed effect.



Vista sistema di chiusura con binario monorotaia ad incasso, pannelli fissi e ante scorrevoli Crystal con maniglia gola in vetro Trama Argento. / Vista door system with built-in single track, Trama Argento glass fixed panels and Crystal sliding doors with groove handle.



Vista sistema di chiusura con binario monorotaia a soffito, ante scorrevoli Plana materico Noce Dorato con maniglia U40 Titanio opaco. / Vista door system with single ceiling track, Noce Dorato materico Plana sliding doors with matt Titanio U40 handle.



# Vista by CRS Pianca

Il sistema di chiusura Vista si caratterizza per la totale assenza di telai e per la modularità al millimetro. Binari e ante vengono sempre realizzati su misura.

A characteristic of the Vista door system is the absence of frames and the wide modularity. Rails and doors are always made to measure.

## Binario monorotaia / Single track

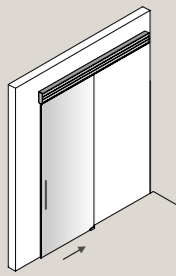

A parete / Wall mounted  
L min 135 max 600 cm  
W min 53.15" max 236.22"

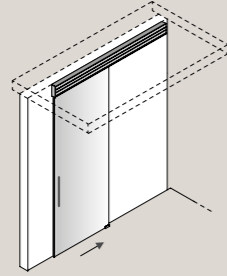

A soffitto / Ceiling mounted  
L min 135 max 600 cm  
W min 53.15" max 236.22"

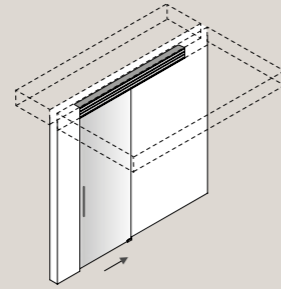

Ad incasso / Recessed  
L min 135 max 600 cm  
W min 53.15" max 236.22"

## Binario monorotaia + pannello fisso / Single track + fixed panel

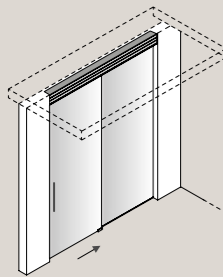

A soffitto / Ceiling mounted  
L min 138 max 600 cm  
W min 54.33" max 236.22"

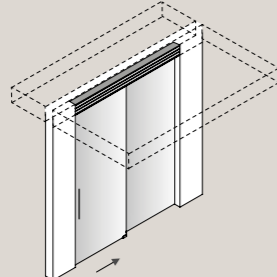

Ad incasso / Recessed  
L min 138 max 600 cm  
W min 54.33" max 236.22"

## Complementi / Complements

### Binario birotaia / Double track

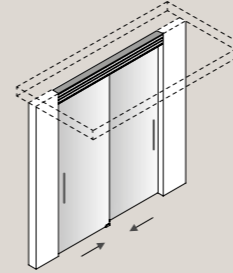

A soffitto / Ceiling mounted

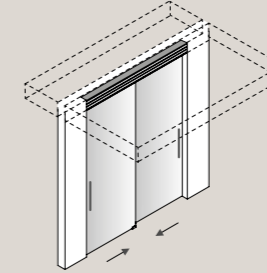

Ad incasso / Recessed

### Angolari / Corner

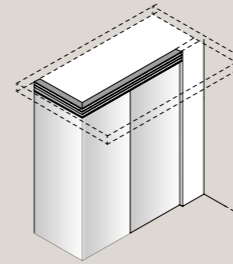

Pannello fisso soffitto / Ceiling mounted fixed panel

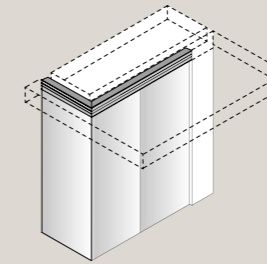

Pannello fisso ad incasso / Recessed fixed panel

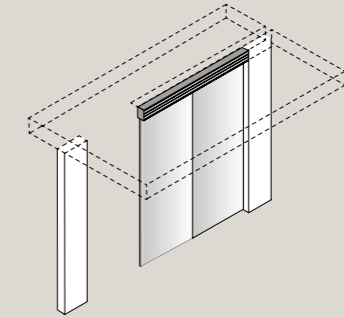

### Pannelli fissi divisori / Fixed panels dividers

Pannello fisso divisorio / Fixed panel divider

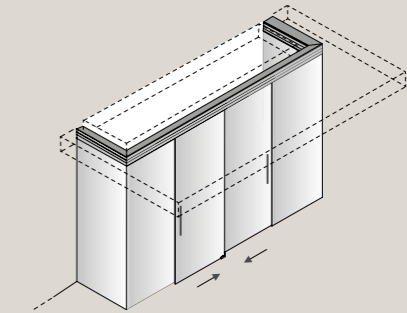

2 pannelli fissi e 2 ante su binario birotaia a soffitto / 2 fixed panels and 2 doors on recessed double track

## Vista by CRS Pianca

# Vista Crystal

## Dimensioni / Dimensions

L da 70 a 120 cm  
H da 190 a 280 cm

W from 27.56" to 47.24"  
H from 74.80" to 110.24"

Pannello fisso,  
L da 70 a 120 cm  
H da 190 a 280 cm

Fixed panel  
W from 27.56" to 47.24"  
H from 74.80" to 110.24"

Binario di scorrimento,  
L max 600 cm

Track  
W max 236.22"

## Maniglie / Handles

Con Gola U40  
With groove U40

## Finiture / Finishes

Finiture anta  
Vetro

Door finishes  
Glass

Finiture Binario  
Alluminio anodizzato o pitturabile  
con tempere murarie

Track Finishes  
Anodised or paintable aluminum

## Finiture maniglia

Metallo  
Laccato opaco

Handles finishes  
Metal

Matt lacquered

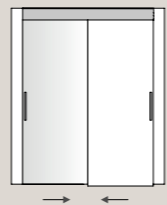
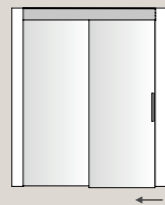
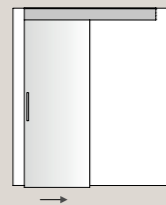
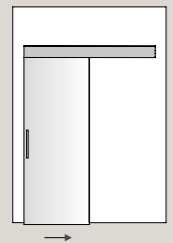

Anta scorrevole  
con binario a parete /  
Sliding door with wall  
mounted track

Anta scorrevole  
con binario a soffitto /  
Sliding door with ceiling  
mounted track

Anta scorrevole e  
pannello fisso con binario  
a soffitto / Door and fixed  
panel on ceiling mounted  
track

2 ante scorrevoli  
con binario a soffitto /  
2 sliding doors with  
ceiling mounted track

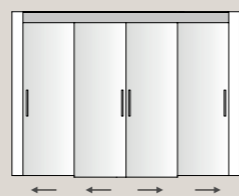
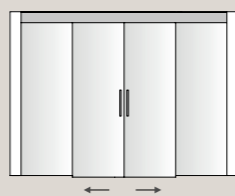
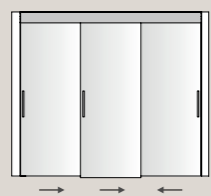
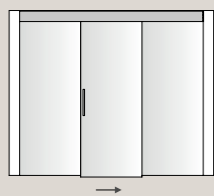

Anta scorrevole e 2  
pannelli fissi binario  
a soffitto / Door and 2  
fixed panels on a ceiling  
mounted track

3 ante scorrevoli  
con binario a soffitto /  
3 sliding doors with  
ceiling mounted track

2 ante scorrevoli  
e 2 pannelli fissi binario  
a soffitto / 2 sliding doors  
and 2 fixed panels on  
a ceiling mounted track

4 ante scorrevoli binario  
a soffitto / 4 sliding doors  
on a ceiling mounted  
track

# Vista Plana

## Dimensioni / Dimensions

L da 70 a 120 cm  
H da 190 a 280 cm

W from 27.56" to 47.24"  
H from 74.80" to 110.24"

Pannello fisso,  
L da 70 a 120 cm  
H da 190 a 280 cm

Fixed panel  
W from 27.56" to 47.24"  
H from 74.80" to 110.24"

Binario di scorrimento,  
L max 600 cm

Track  
W max 236.22"

## Maniglie / Handles

U40

## Finiture / Finishes

Finiture anta

Laccato opaco o lucido, Essenza,  
Materico, Pitturabile con tempere  
murarie

Door finishes

Matt or High gloss lacquered, Wood,  
Materico, Paintable

Finiture Binario

Alluminio anodizzato o pitturabile  
con tempere murarie

Track Finishes

Anodised or paintable aluminum

Finiture maniglia

Metallo, Laccato opaco

Handles finishes

Metal, Matt Lacquered

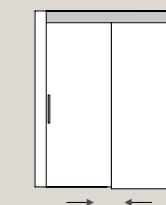
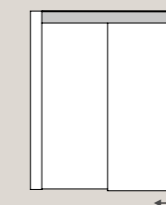
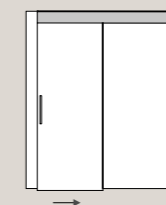
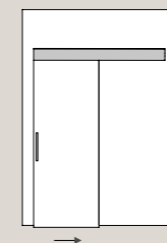

Anta scorrevole  
con binario a parete /  
Sliding door with wall  
mounted track

Anta scorrevole  
con binario a soffitto /  
Sliding door with ceiling  
mounted track

Anta scorrevole e  
pannello fisso con binario  
a soffitto / Door and fixed  
panel on ceiling mounted  
track

2 ante scorrevoli  
con binario a soffitto /  
2 sliding doors with  
ceiling mounted track

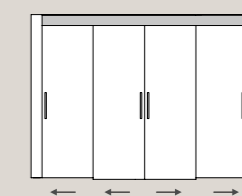
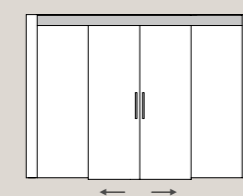
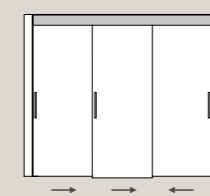
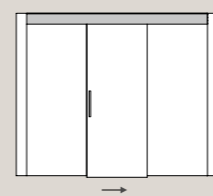

Anta scorrevole e 2  
pannelli fissi binario  
a soffitto / Door and 2  
fixed panels on a ceiling  
mounted track

3 ante scorrevoli  
con binario a soffitto /  
3 sliding doors with  
ceiling mounted track

2 ante scorrevoli  
e 2 pannelli fissi binario  
a soffitto / 2 sliding doors  
and 2 fixed panels on  
a ceiling mounted track

4 ante scorrevoli binario  
a soffitto / 4 sliding doors  
on a ceiling mounted  
track

**Pianca S.p.A**

Via dei Cappellari, 20  
31018 – Gaiarine, Treviso  
Italy

T +39 0434 756911  
F +39 0434 75330

info@pianca.com  
pianca.com

p. iva IT01682580269

Vietata la riproduzione a qualsiasi scopo.  
Campione promozionale gratuito non destinato alla vendita.  
Escluso iva art.2 comma 3D.P.R. 633/72  
Esonerato da documento di trasporto art.4 punto 6 d.p.r.627/78

Reproduction prohibited for any purpose.  
Free promotional sample not for sale.  
Excluding VAT Article 2 paragraph 3D.P.R. 633/72  
Exempted from transport document art.4 point 6 d.p.r.627/78

© Pianca 2023

Pianca azienda  
certificata FSC®



**Il marchio della  
gestione forestale  
responsabile**

Chiedi i prodotti  
certificati FSC®